

DT TRUCK 28FE



DT TRUCK 92FE

DOTAZIONE STANDARD

Cesto - Alluminio 1800x700x1100 mm, portata max 250 kg

Comando avvio/arresto motore dal cesto

Comando dal cesto per segnalatore acustico

Connessione elettrica 230V nel cesto

Contaore

Controllo anticollisione tra bracci e cabina del veicolo

Dispositivo di stabilizzazione automatica

Impianto idraulico a filtraggio differenziato con filtri ad alta efficienza

Livella multiassiale

Luci intermittenti sugli stabilizzatori

Pompa di emergenza manuale

Rotazione cesto $\pm 90^\circ$

Rotazione torretta 1440°

Schermo CAN-bus 3.5" in cabina

Sistema di controllo via CAN-bus

Teleassistenza remota in tempo reale (CRSS)

Valvole di blocco flangiate sui cilindri

Verniciatura - Braccio telescopico:
Bianco RAL 9010

Verniciatura - Cilindri, parte aerea and pistoni:
Bianco RAL 9010

Verniciatura - Nero

STANDARD EQUIPMENT

Cage - Aluminium 5'11"x2'4"x3'7", max load 551 lbs

Start/Stop engine from the cage

Acoustic warning from the cage

110/120V electric connection in the cage

Hour counter

Boom and truck cabin anti-collision device

Automatic stabilization device

Fully compensated hydraulic system with high pressure filtering system

Multi-axial level

Blinking lights on outriggers

Emergency hand pump

Cage rotation $\pm 90^\circ$

Turret rotation 1440°

Display CAN-bus 3.5" on the cab

CAN-bus control system

Remote management and diagnostic software (CRSS)

Flanged lock valves on cylinders

Painting - Telescopic booms:
White RAL 9010

Painting - Cylinders, turret and pistons:
White RAL 9010

Painting - Mainframe: Black



DT TRUCK 28FE

ACCESSORI DISPONIBILI

Argano elettrico, portata massima 250 kg
Barre paraciclisti
Camion con guida a destra
Cassetta degli attrezzi
Carica batteria per autocarri
Cesto - Alluminio 700x700x1100 mm, portata massima 120 kg
Cesto - Vetrosesina 800x600x1100 mm, portata massima 120 kg
Cesto - Vetrosesina 1200x620x1100 mm, portata massima 220 kg
Cesto - Carico materiali con sponde abbattibili 1400x700x550/2430x1166x50 mm, portata massima 220 kg
Comandi di stabilizzazione dal cesto
Connessione aria/acqua tra cesto e torretta, pressione max 225 bar
Dispositivo anti-collisione a protezione del cesto con tecnologia sonar
Dispositivo di chiusura automatica
Dispositivo di apertura automatica
Elettropompa monofase con caricabatteria tampone
Filocomando a terra da 5 m
Gancio di sollevamento, portata massima 280 kg completo di certificazione gru
Imbracatura di sicurezza
Interruttore magnetotermico di protezione sulla linea elettrica
Linea cesto con spine/prese 110V (extra USA)
Pedale uomo morto al cesto (extra USA)
Piastre di appoggio a terra con relativo porta piastre
Radiatore olio idraulico
Radiocomando
Radiocomando nel cesto + postazione fissa a terra
Rotolampada magnetica
Software per la gestione della macchina da remoto
Spazzole anti detriti nei bracci
Stabilizzatori maggiorati con piastre in legno
Traverse posteriori estendibili idraulicamente
Verniciatura speciale - Telaio
Verniciatura speciale - Parte aerea, cilindri e stabilizzatori

STANDARD COMPLIANCE

ANSI 92.20
UNI EN 280
CSA B354.6
CE
Crane certification (EN 12999 standard certified)

OPTIONS & ACCESSORIES

Electric winch, max load 551 lbs
Anti cyclist protection bars
Right hand drive truck
Tool box
Truck battery charger
Cage - Aluminium 2'4"x2'4"x3'7", max load 265 lbs
Cage - Fiberglass 2'7"x2'x3'7", max load 265 lbs
Cage - Fiberglass 3'11"x2'x3'7", max load 485 lbs
Cage - Material handling with collapsible sides 4'7"x2'4"x1'10"/7'12"x3'10"x1'8", max load 485 lbs
Stabilization controls from the cage
Air/Water connection between cage and turret, max pressure 225 bar
Ultrasonic anti-collision alarm for cage protection
One-click auto-closing function
One-click auto-opening function
Mono-phase electro pump with its buffer battery charger
16' length wired controller, control at ground
Hoist Hook, max load 617 lbs crane certification included
Safety harness
Circuit breaker in the cage
Basket line with 110V plugs/sockets (extra USA)
Dead man pedal in the cage (extra USA)
Outrigger pads along with corresponding pad holder
Hydraulic oil radiator
All function radio cooler
Radio control on the cage + fixed control station at ground
Magnetic xenon beacon
Remote management software
Anti-debris brushes on booms
Extended stroke outriggers with wooden pads
Rear stabilizing beams with automatic hydraulic extension
Special painting - Mainframe
Special painting - Upper part, cylinders and outriggers

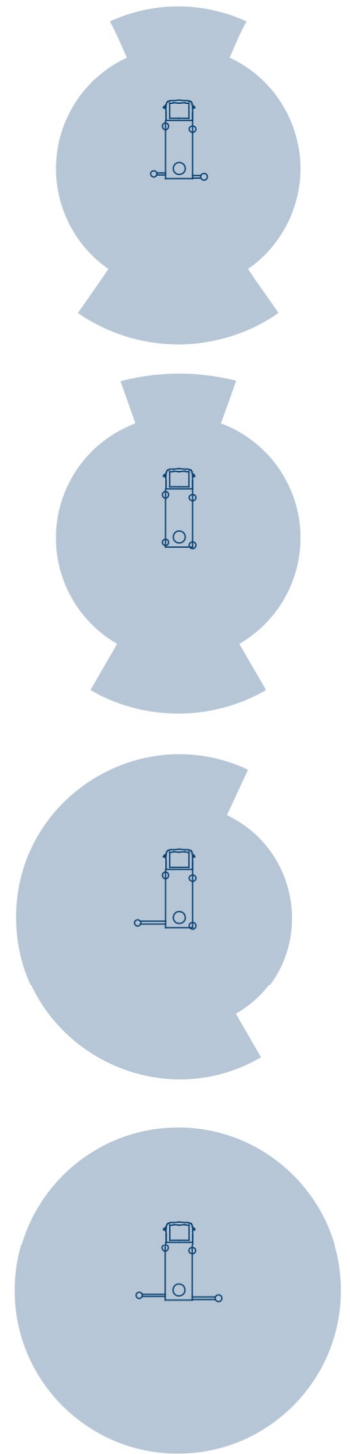
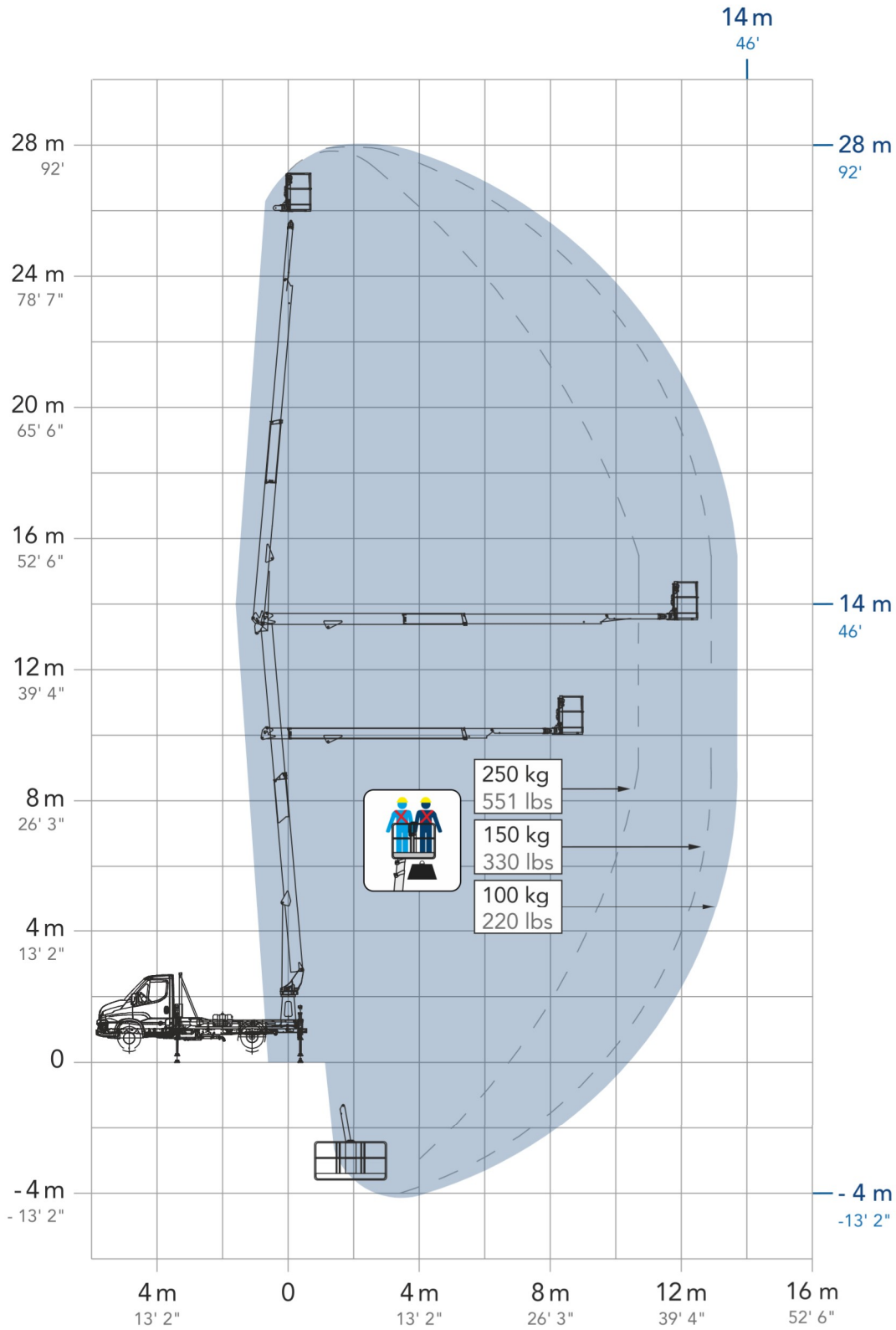

depending on chassis

DIMENSIONI

A	Lunghezza cesto	1800 mm
B	Profondità cesto	700 mm
C	Altezza della macchina	2750 mm
D	Lunghezza della piattaforma	6700 mm
E	Lunghezza totale	7300 mm
F	Larghezza della macchina	2100 mm
G₁	Estensione parziale stabilizzatore	200 mm
G	Estensione totale stabilizzatore	975 mm

* le misure variano in base al telaio

DIMENSIONS

Cage length	5 ft 11 in
Cage width	2 ft 4 in
Height	9 ft
Platform length	22 ft
Overall length	24 ft
Width	6 ft 11 in
Partial stabilizer extension	8 in
Full stabilizer extension	3 ft 2 in

* measurements depend on chassis

PRESTAZIONI

Altezza di lavoro	28 m
Sbraccio laterale	14 m
Punto di scavalco	13,5 m
Lavoro negativo	- 4 m
PTT minimo	3,5 T

PERFORMANCE

Working height	92 ft
Horizontal outreach	46 ft
Up and over clearance	44 ft 4 in
Negative work (below ground level)	- 13 ft 2 in
Minimum GVW	7716 lbs



28 m
92 ft

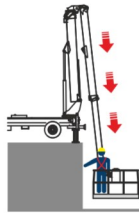

-4 m
-13 ft 2 in

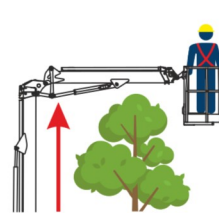

13,5 m
44 ft 4 in

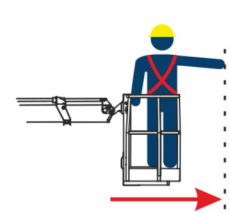

14 m
46 ft

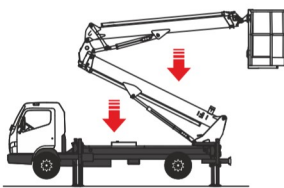

AUTO

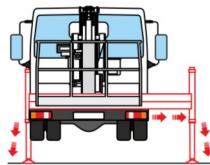

1440°



90°+90°

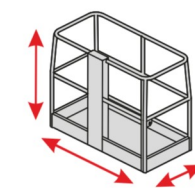
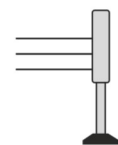

ALUMINIUM
1,8X0,7X1,1
5'11"X2'4"X3'7"



ELECTRONIC

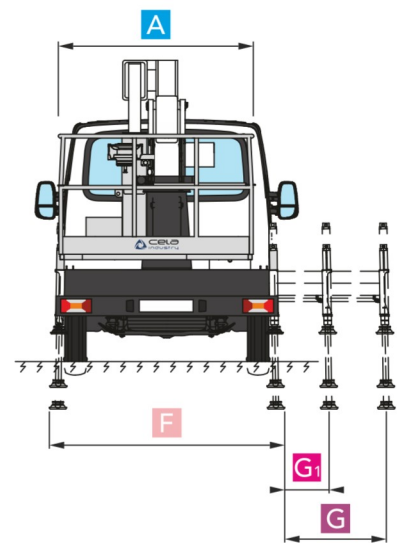
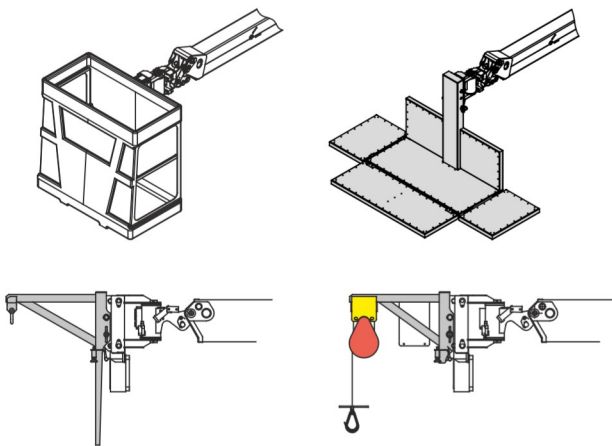
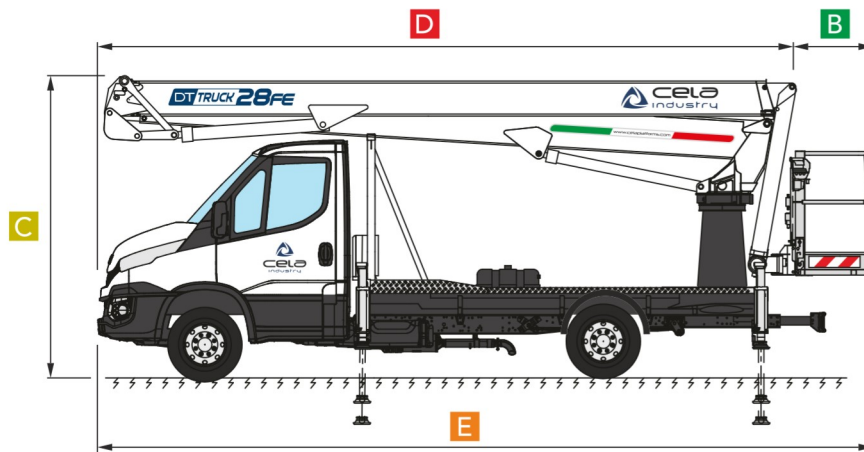

Come un ascensore
Like an elevator

Sbarco in quota autorizzato
Authorized height landing

Tutto in uno
All in one

Ti spianiamo la strada
We level the road for you

Siamo i più forti
We are the strongest ones

250 KG
551 lbs

280 KG
617 lbs